

Fiilex

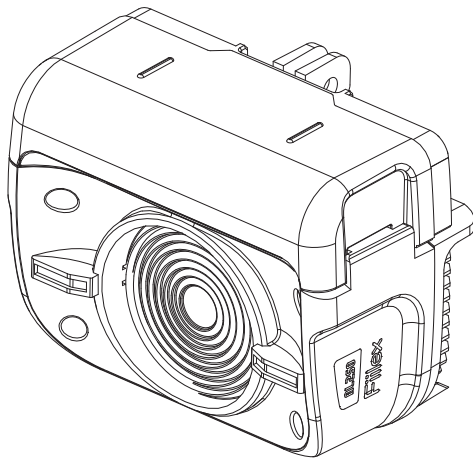

AL250

FLXAL25

User Manual

General Notes:

- Please read the following operating instructions very carefully before using this fixture for the first time. It contains important information on the operation of Fiilex lighting equipment.
- For your own safety, please follow all safety instructions and warnings.
- Please also follow the operating instructions of the light and power adapter manufacturers.
- Keep these operating instructions for you and subsequent users for reference in the future.
- For further information, please ask your retailer or inquire at your local authorities. Only use Fiilex spare parts and accessories (www.fillex.com).

Basic Operation (refer to Parts Diagram on following page)

- Mounting

The AL250 attaches to a drone via its strong adhesive on the Mounting Base (1).

- Powering On

The AL250 is powered by a removable Li-ion Rechargeable Battery (2). Use the included USB Cable (9) to charge the battery while it is on the fixture. Press Power (6) to turn the light on.

Light	Action	Charging Status	Battery Status
●	Constant	Charged	100 - 40%
●	Constant	N/A	40 - 20%
●	Constant	Charging	20 - 0%
●	Fast Blink 10 seconds then off	N/A	Error

Note

- The AL250 will enter the Self Protection Mode when the heat sink is overheated (The light output will drop down to 30%).
- The AL250 requires rechargeable Li-ion batteries. Use only Fiilex-approved batteries and chargers.
- You must fully charge the battery for the first use. A discharged battery recharges fully in approximately 3 hours.
- For connection to an electrical supply outside the U.S., the proper adapter must be used for the power outlet. Use of the wrong adapter and/or power configuration could result in damage to the AL250 and void the warranty.

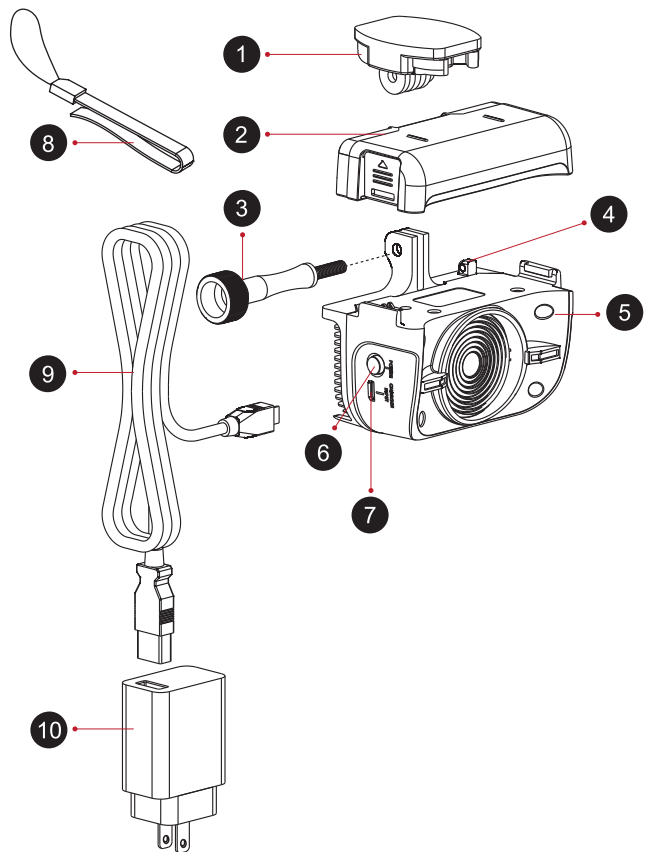

Parts Diagram

1. Mounting Base
2. Li-ion Rechargeable Battery
3. Mounting Knob
4. Hole for Safety Lanyard
5. AL250 (Light Body)
6. Power (Charge Indicator)
7. Charger Input
8. Safety Lanyard
9. USB Cable
10. Charger

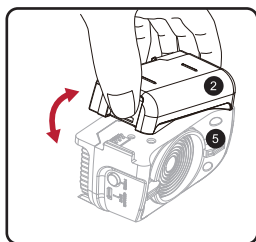

Installing/Removing the Battery

To install or remove the battery, push and hold the battery release.

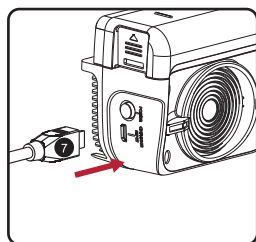

Charging

Insert the USB Cable (9) into the charger input on the AL250. Plug the power cable into a standard AC wall outlet to charge.

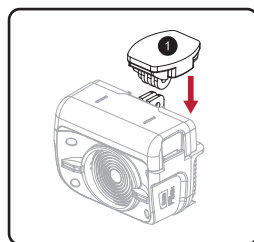

Installing Mount

Attach the Mounting base (1) to the AL250.

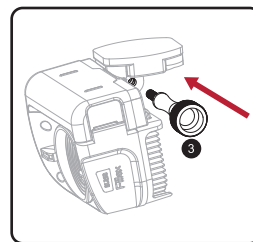

Installing Mounting Knob

Insert the Mounting Knob (3) into the mounting base and tighten.

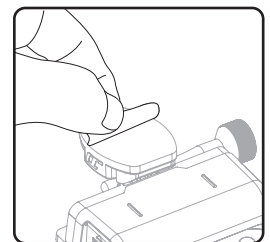

Remove Sticker to Mount

Tear away the sticker on the Mounting Base (1).

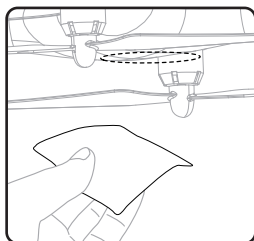

Preparing the Attachment

Clean attachment surface on bottom of drone with alcohol wipe to guarantee secure attachment.

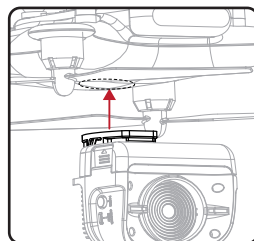

Attaching to the Drone

Stick the AL250 on the bottom of your drone.

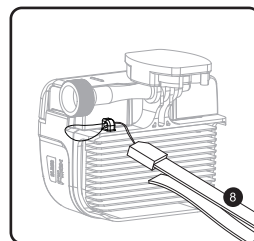

Secure Lanyard

Fasten the Safety Lanyard (8) to the hole (4).

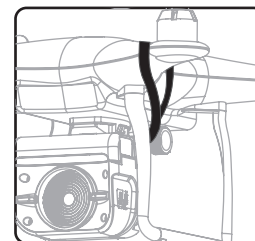

Fasten to Drone

Secure the Safety Lanyard (8) onto the propeller arm.

Compatible Accessories

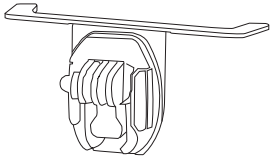

AL250 Adhesive Mount

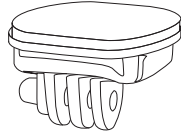

AL250 Mount Plate Type I

*Mount installation not necessary on drones with existing GoPro mounts.

Specifications

CCT Range	3000-5600K Continuous Tuning
Light Engine	Dense Matrix LED
Power Draw	30W Max
DC Input	9 - 13V DC
AC Input	100 - 240V AC, 50 ~ 60Hz
Battery	18.7Wh Li-ion Rechargeable Battery (7.2V, 2600mAh)
Weight	0.6lbs / 0.3kg
Size (L x W x H)	3.7in x 3.0in x 2.0in / 9.3cm x 7.6cm x 5.1cm
Mount	GoPro Mount
Thermal Design	Passive Cooling System
Operating Temperature	32 - 104°F / 0 - 40°C
LED Lifetime	42,000 hours
Certifications	FCC, CE, UL

Safety

- Do NOT remove the battery from AL250 when when power is on.
- Do NOT attempt to disassemble the body of AL250.
- Do NOT install AL250 in a damp or wet area.
- Use only the included power supply.
- Use only a soft, dry towel to gently clean the exterior of the AL250.
- Do NOT attempt to disassemble, deform, solder, or heat battery.
- Do NOT insert battery with different connector.
- Stop using if battery expands or the temperature is over 40 °C (104 F) or under 0 °C (32 F).
- Do NOT short circuit battery.
- Do NOT leave AL250 inside a hot vehicle or trunk. Avoid using AL250 in direct sunlight for prolonged amounts of time.
- If batteries will not be used for an extended length of time, they should be fully discharged sealed in a plastic bag, and stored in a refrigerator.
- Never leave a battery operated device unattended while it is running .

Warranty

Unless otherwise stated, your product is covered by a **one year parts and labor limited warranty**. Fiilex guarantees, to the original buyer, that this product is to be free of defects in both workmanship and material for a period of one year from the date of shipment. This warranty extends to all products which have proved defective through normal use but excludes products that have been disassembled, modified or misused by the buyer or any other person. This warranty is in lieu of all other warranties, and disclaims all warranties expressed or implied, including any warranty of merchantability, fitness for a particular purpose, or arising from the course of dealing between the parties or usage of trade.

Returning an Item Under Warranty for Repair

It is necessary to obtain a Return Authorization Number (RA#) from your dealer/point of purchase BEFORE any units are returned for repair. Fiilex will make the final determination as to whether or not the unit is covered by warranty. Fiilex will replace or repair to proper working condition any products that are returned under warranty. Products repaired or replaced under warranty are under warranty only for the remaining unexpired period of time of the original warranty.

Any Product unit or part returned to Fiilex must be packaged in a suitable manner to ensure the protection of such Product unit or parts. The package must be clearly and prominently marked to indicate that the package contains returned product units or parts with a Return Authorization (RA#) number. All returned product units or parts must be accompanied by a written explanation of the alleged problem or malfunction.



www.fiilex.com

1689 Regatta Blvd. Richmond, CA 94804
| (510) 620-5155 | fiilex@fiilex.com